

CG-406-A

CG-406-B

CG-406-D

CG-406-E

CG-406-F

CG-406-G



CI-406-A

CI-406-B

CI-406-D

CI-406-E

CI-406-F

CI-406-G

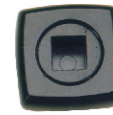
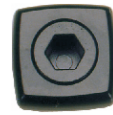

A

B

D

E

F

G

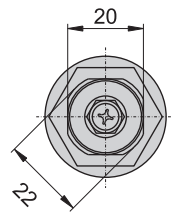
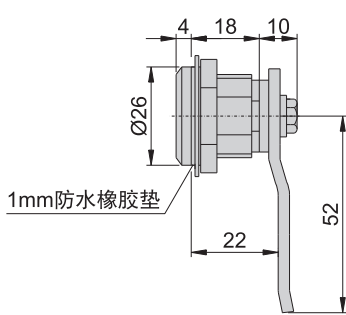
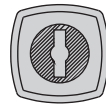
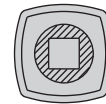
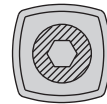
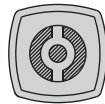
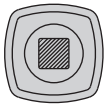

开孔尺寸图

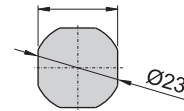

机械锁

材 质	锌合金(ZDC)
表面处理	CA-406、CD-406、CG-406---镀铬-光面 CB-406、CF-406、CI-406---电著涂装黑色
特 征	防水型
适用门扇	200×150
备 注	钥匙C-406-H(长), C-406-H-2(短), 详见P32。钥匙需另外购买

## 彩色把手

CPA-406-A

CPA-406-B

CPA-406-C

CPA-406-D

CPA-406-E

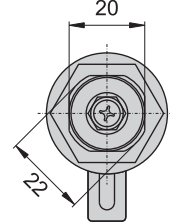
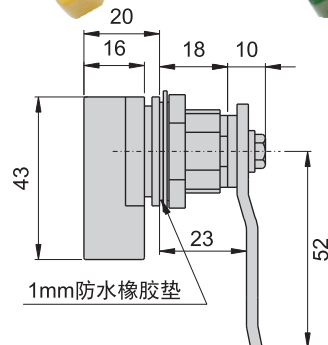
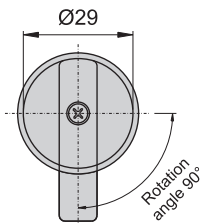

开孔尺寸图

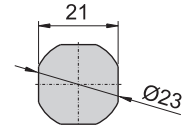

材 质	主体---锌合金(ZDC), 外壳---塑胶(PP)
特 征	防水型
适用门扇	200×150