

CL-202(S)

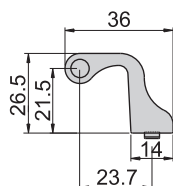

材 质	铁
表面处理	后钮座---(S)喷砂、镀铬
	后钮管---材料本质
	心轴---电锤

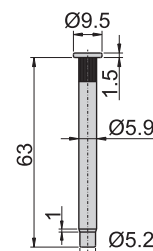
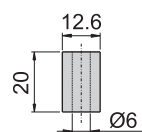
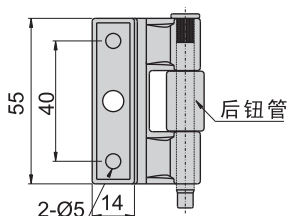
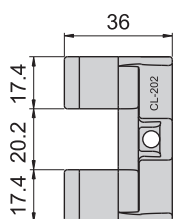

丁 双

75#

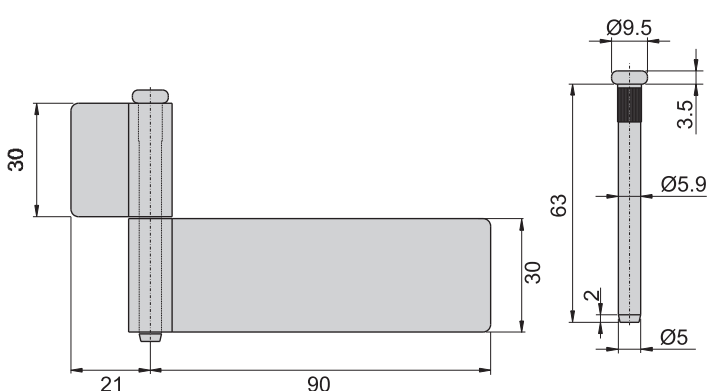
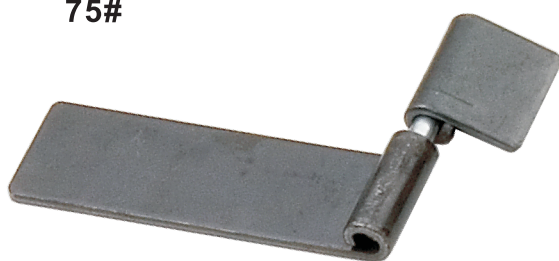

材 质	铁
表面处理	叶子---材料本质
	心轴---电锤

